

Available Finishes / Materials:

- EG -- Electro-galvanized
- GN -- Green Powder Coat
- HD -- Hot dipped galvanized
- S4 -- 304 stainless steel
- S6 -- 316 stainless steel
- YC -- Yellow chromate

Standard Finish: EG

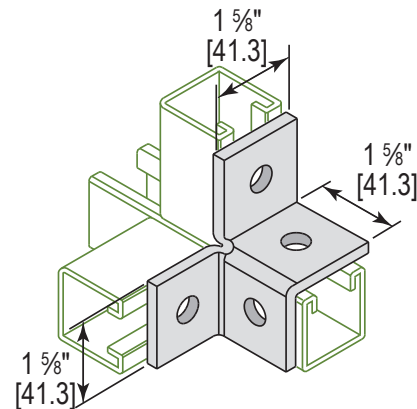

Catalog Number: W20 0000EG
Weight: 0.69 Lbs.

Material is 1 5/8" [41.3] wide x 1/4" [6.3] thick unless specified. Holes are 9/16" (14.3) diameter, 13/16" [20.6] center to edge on 1 5/8" [47.6] centers unless specified.

Material Specifications and Finishes

Carbon Steel – ASTM A1011-00 SS GR 33 or ASTM A1011-00CS Type B

EG – Electro-Galvanized. Electroplating deposits zinc on the surface of the steel by electrolysis from a bath of zinc salts. Recommended for relatively dry indoor use. This is the standard coating for most Phoenix products. Thickness of applied zinc is between 0.2 mils to 0.5 mils [5.1 μm to 12.7 μm]. Coatings on Phoenix EG products meet ASTM B633 SC1 Type III.

GN – GN – Green Powder Coat. A Polyester powder coating is electrostatically applied after fabrication. The powder is then baked on creating a 1.38 to 1.77 mil [35 – 45 μm] thick coating. The hardness of this coating meets ASTM D-3363-74, the impact rating meets ASTM D-2794-93 and the gloss meets ASTM D-523-85. This creates a coating that is resistant to chipping, peeling and corrosion. Available in many colors by special order

HD – Hot Dip Galvanized After Fabrication. Fabricated product is dipped in molten zinc and is completely covered on all surfaces. Recommended for outdoor use. Coatings on Phoenix HD products meet ASTM A123/153. The zinc coating is typically 2.6 mils [66.0 μm] or 1.5 oz. per square foot [0.46 kg per square meter] per side.

S4 – 304 Stainless Steel – ASTM A240 (Type 304)

S6 – 316 Stainless Steel – ASTM A240 (Type 316),
316 Stainless Steel Nuts – ASTM A276-03

YC – Yellow Zinc Dichromate. A 0.5 mil [12.7 μm] electro-galvanized zinc plating meeting ASTM B633 SC1 Type III is applied to the surface of the metal. Yellow Dichromate is applied over the zinc. This results in a yellowish gold appearance and acts as a nonporous barrier sealant that is corrosion resistant and can be painted.

Note: Specifications subject to change without notice.

Project:	Date:	Phone:
Submitted By:	Address:	
Comment		